

HEATERS

QUICK - REFERENCE GUIDE

ITEM	DETAILS	PAGE
HEATERS	COMPLETE UNITS	277 - 278
HEATER COILS	(see detailed list of OEM replacements below)	279 - 283
HEATER SPARES	CABLES, FITTINGS, HOSE	284
HEATER SPARES	VALVES	285

OEM Replacement Coils

VEHICLE	PAGE
FORD	- 279
G M H	- 280
HYUNDAI	- 281
MAZDA	- 281
MINI	- 281
NISSAN	- 282

VEHICLE	PAGE
PEUGEOT	- 282
RED DOT	- 282
ROVER	- 282
TOYOTA	- 283
VOLKSWAGEN	- 283
VOLVO	- 283

Heaters: Complete Units

AMC HEATER UNITS

AMC Model UHD-1



HT - 12010 12 v
HT - 24010 24 v

SPECIFICATIONS

UNIT TYPE: HOT WATER TYPE, CABLE OPERATED, UNDERDASH MOUNT.
CAPACITY: 7140 BTU/hr (1800 KCal/hr)
CONSTRUCTION: PLASTIC CASE
DEMISTER: OPTIONAL EXTRA
CURRENT DRAW: 13 AMPS AT 12 VOLTS
6.5 AMPS AT 24 VOLTS
WIDTH: 380 mm
DEPTH: 305 mm
HEIGHT: 155 mm
WEIGHT: 4 kgs

OPTIONS:

HTA-85010 DEMISTER KIT (CONTAINS DEMISTER DUCTS, HEATER VALVE AND CONTROL CABLE)

HT - 12020 12 v
HT - 24020 24 v

SPECIFICATIONS

UNIT TYPE: HOT WATER TYPE, CABLE OPERATED, FLOOR OR WALL MOUNT.
CAPACITY: 7936 BTU/hr (2000 KCal/hr)
CONSTRUCTION: STEEL CASE
DEMISTER: OPTIONAL EXTRA (SEE OPTIONS BELOW)
CURRENT DRAW: 13 AMPS AT 12 VOLTS
6.5 AMPS AT 24 VOLTS
WIDTH: 350 mm
DEPTH: 155 mm
HEIGHT: 210 mm
WEIGHT: 6 kgs

OPTIONS:

HTA-85023 ACCESSORY KIT (CONTAINS HEATER CONTROL VALVE AND CABLE)

HTA-85026 DEMISTER KIT (CONTAINS DEMISTER DUCTS, ADAPTORS AND TUBING)

AMC Model UHD-2



RED DOT HEATER UNITS



Red Dot Model R2020

HT- 12150 12 v
HT- 24150 24 v

SPECIFICATIONS

UNIT TYPE: HOT WATER OR OIL, CABLE OPERATED, BULKHEAD, FIREWALL OR FLOOR MOUNT.
CAPACITY: 17,000 BTU/hr (4290 KCal/hr)
CONSTRUCTION: STEEL CASE
DEMISTER: NOT INCLUDED, BUT HAS PROVISION FOR DUCT
CURRENT DRAW: 9 AMPS AT 12 VOLTS
4.5 AMPS AT 24 VOLTS
WIDTH: 520 mm
DEPTH: 204 mm
HEIGHT: 130 mm
WEIGHT: 5 kgs

Heaters: Complete Units**RED DOT HEATER UNITS****Red Dot Model R254**

HT - 12165 12 v
HT - 24165 24 v

SPECIFICATIONS

UNIT TYPE: HOT WATER TYPE, CABLE OPERATED,
BULKHEAD, FIREWALL OR FLOOR MOUNT.
CAPACITY: 16,000 BTU/hr (4032 KCal/hr)
CONSTRUCTION: STEEL CASE
CURRENT DRAW: 3.3 AMPS AT 12 VOLTS
1.7 AMPS AT 24 VOLTS
WIDTH: 241 mm
DEPTH: 184 mm
HEIGHT: 163 mm
WEIGHT: 3 kgs

**Red Dot Model R4013H**

HT - 12180 12 v
HT - 24180 24 v

SPECIFICATIONS

UNIT TYPE: HOT WATER TYPE, CABLE OPERATED,
BULKHEAD, FIREWALL OR FLOOR MOUNT.
CAPACITY: 20,000 BTU/hr (5040 KCal/hr)
CONSTRUCTION: STEEL CASE
DEMISTER: NOT INCLUDED, BUT HAS PROVISION
FOR DUCT
CURRENT DRAW: 11 AMPS AT 12 VOLTS
5.5 AMPS AT 24 VOLTS
WIDTH: 295 mm
DEPTH: 340 mm
HEIGHT: 295 mm
WEIGHT: 7 kgs

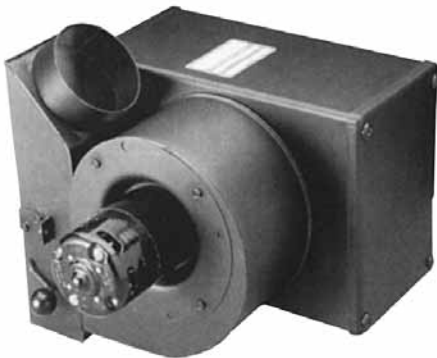
**ELECTRIC HEATER UNITS****Universal Electric Heater**

UNIVERSAL 300 watt ELECTRIC HEATER UNIT

HT - 35412 12 volt
HT - 35424 24 volt

WIDTH: 185 mm
DEPTH: 115 mm
HEIGHT: 165 mm
WEIGHT: 2 kgs



Heater Coils: OEM Replacement

FORD

VEHICLE	MODEL / CODE	YEAR	PART No.	TYPE / OTHER / OEM REFERENCE
EXPLORER			HTC-32111	
FALCON	XA - XC		HTC-32331	WITHOUT AIR
FALCON	XD - XE	TO - 01/83	HTC-32403	
FALCON	XE	01/1983 - ON	HTC-32407	
FALCON	XF, ZL Fairlane		HTC-32410	
FALCON	EA - AU		HTC-32440	
LASER	KA - KB		HTC-33472Z	
LASER	KC	TO - 11/85	HTC-33475	
LASER	KC-KE	11/1985 - ON	HTC-33484	
LASER	KF-KH	TO - 01/93	HTC-33528	
TELSTAR	AR, AS		HTC-34170	
TELSTAR	AT		HTC-34175	

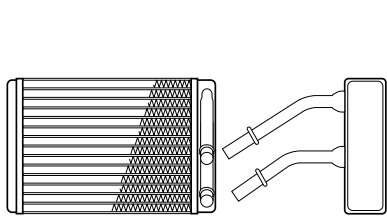

HTC-32111

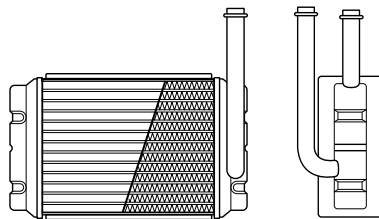

HTC-32331

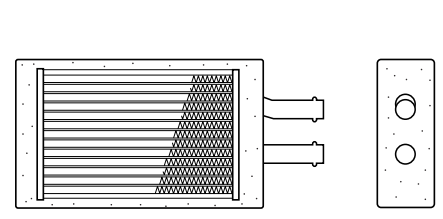

HTC-32403

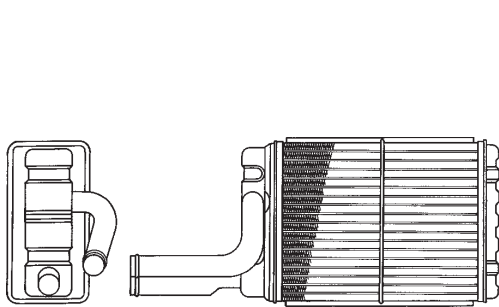

HTC-32407



HTC-32410



HTC-32440

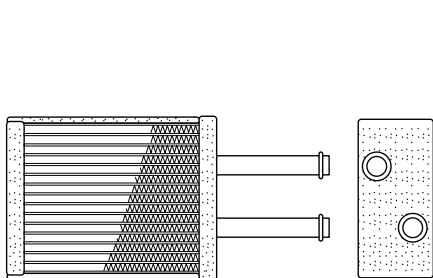

HTC-33472Z

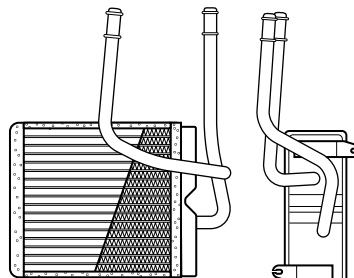

HTC-33475

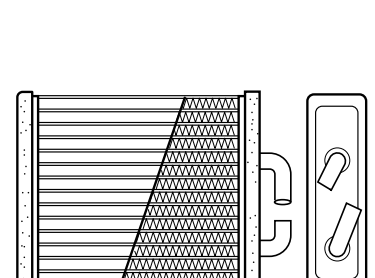

HTC-33484

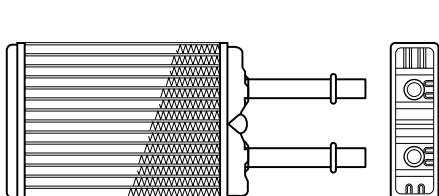

HTC-33528

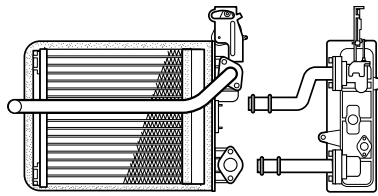

HTC-34170

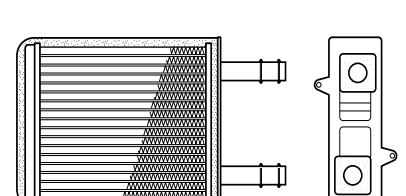

HTC-34175

Heater Coils: OEM Replacement**GENERAL MOTORS HOLDEN**

VEHICLE	MODEL / CODE	YEAR	PART No.	TYPE / OTHER / OEM REFERENCE
CAMIRA	JB-JE		HTC-37721	
COMMODORE	VB - VH		HTC-38014	WITH DELCO COMPRESSOR
COMMODORE	VB - VH		HTC-38015	
COMMODORE	VK, EARLY VL		HTC-38071	OE: VS16879
COMMODORE	VN - VS		HTC-38161	
COMMODORE	VT	TO - 26/11/98	HTC-38217	
COMMODORE	VT - VX	27/11/98 ON	HTC-38217	
HQ-HZ			HTC-38955	WITHOUT GENUINE AIR
VECTRA		1995 - ON	HTC-40129	

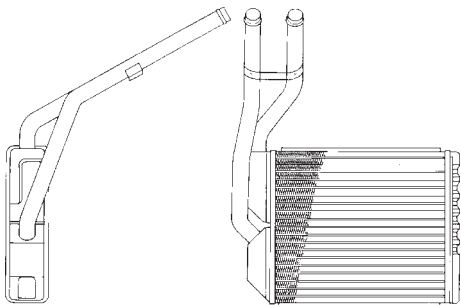

HTC-37721

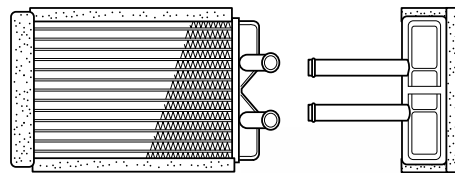

HTC-38014

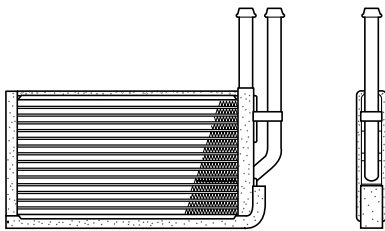

HTC-38015

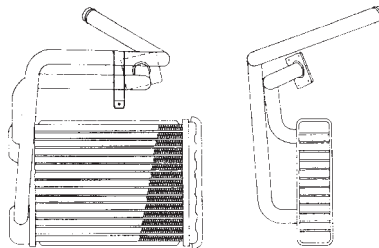

HTC-38071



HTC-38161



HTC-38217

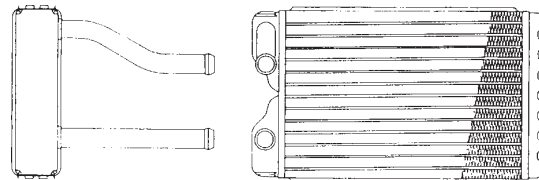

HTC-38955



HTC-40129

Heater Coils: OEM Replacement

HYUNDAI

VEHICLE	MODEL / CODE	YEAR	PART No.	TYPE / OTHER / OEM REFERENCE
EXCEL LANTRA S COUPE SONATA		1995 - ON	HTC-45362	
		06/95 - ON	HTC-45773	

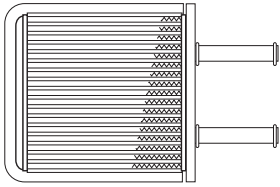

HTC-45362

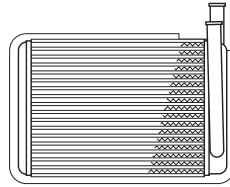
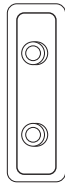

HTC-45773



MAZDA

VEHICLE	MODEL / CODE	YEAR	PART No.	TYPE / OTHER / OEM REFERENCE
121	DB	1990 - 1993	HTC-60146	
323		1982 - 1985	HTC-60255	
626	GC		HTC-60294Z	

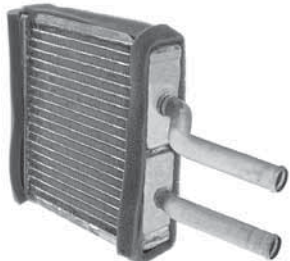

HTC-60146

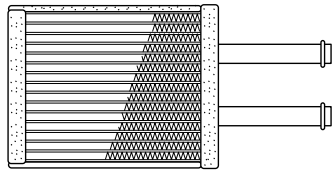

HTC-60255

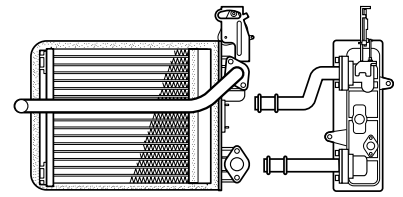
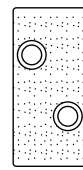

HTC-60294Z

MITSUBISHI

VEHICLE	MODEL / CODE	YEAR	PART No.	TYPE / OTHER / OEM REFERENCE
MAGNA	TM-TP	1991 - 1996	HTC-66178	USE ORIGINAL PIPES AND ORDER HTS-94792 O-RING
	TR, TS		HTC-66219	
	TE, TF, TH, TJ		HTC-66222	
SIGMA	GE - GH		HTC-67228	
SIGMA	GJ - GN		HTC-67264	

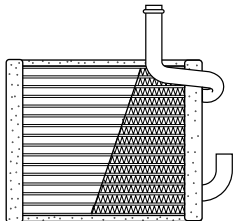

HTC-66178

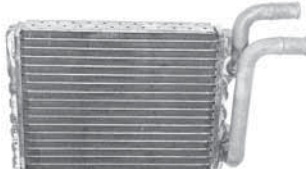
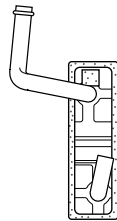

HTC-66219

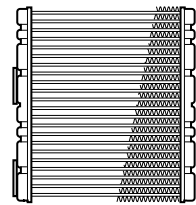

HTC-66222

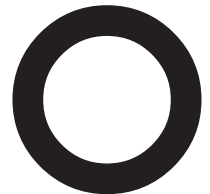
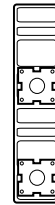

HTS-94792
o-ring for HTC-66222
(shown actual size)

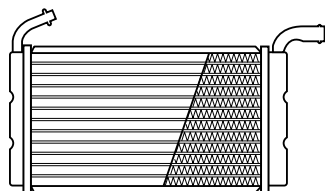

HTC-67228

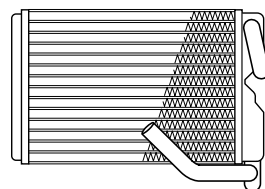
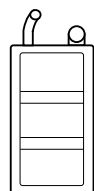

HTC-67264

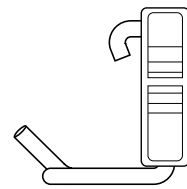

Heater Coils: OEM Replacement**NISSAN**

VEHICLE	MODEL / CODE	YEAR	PART No.	TYPE / OTHER / OEM REFERENCE
BLUEBIRD	SERIES I & II	TO - 01/85	HTC-70815	
BLUEBIRD	SERIES III	02/85 - ON	HTC-70823	

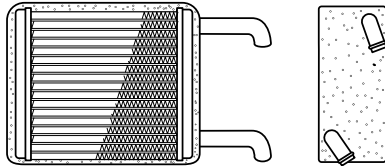

HTC-70815

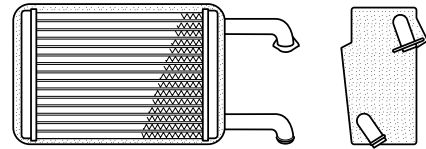

HTC-70823

PEUGEOT

VEHICLE	MODEL / CODE	YEAR	PART No.	TYPE / OTHER / OEM REFERENCE
PEUGEOT	306	1993 - 1997	HTC-74251	

HTC-74251

**RED DOT**

VEHICLE	MODEL / CODE	YEAR	PART No.	TYPE / OTHER / OEM REFERENCE
RED DOT	R8545		HTC-75845	1-0771-0 76R1510
RED DOT	R9737		HTC-75937	1-0955-0 76R1850

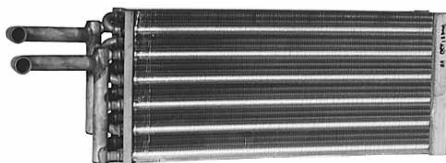

HTC-75845

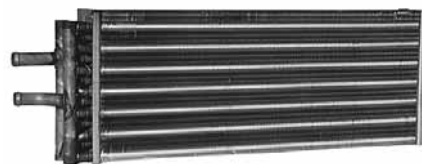

HTC-75937

ROVER

VEHICLE	MODEL / CODE	YEAR	PART No.	TYPE / OTHER / OEM REFERENCE
RANGEROVER		1972 - 1988	HTC-77178	

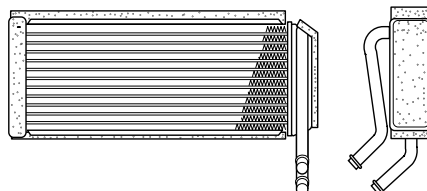

HTC-77178

Heater Coils: OEM Replacement

TOYOTA

VEHICLE	MODEL / CODE	YEAR	PART No.	TYPE / OTHER / OEM REFERENCE
AVALON		2000 - ON	HTC-84502Z	
CAMRY	SV20, 21, 22		HTC-85189	
CAMRY	SDV10, VDV10		HTC-85217	
CAMRY	MCV20, SXV20	1997 - ON	HTC-85225	
CORONA	ST141		HTC-86174	
COROLLA	AE80, AE82	01/85 - 12/88	HTC-86330	
COROLLA	AE101,102	07/97 - 07/99	HTC-86388	



HTC-84502Z

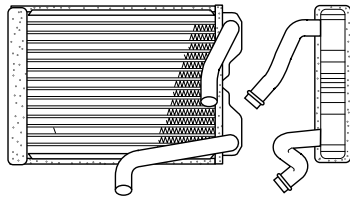

HTC-85189

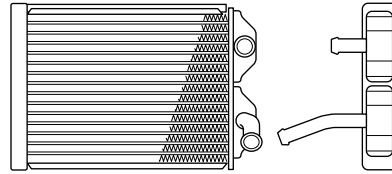

HTC-85217



HTC-85225

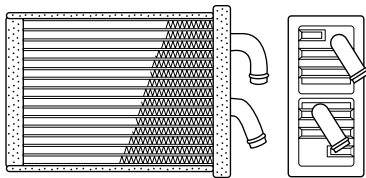

HTC-86174



HTC-86330

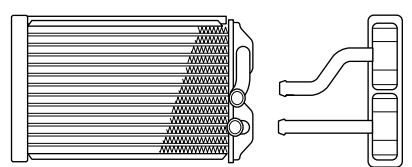
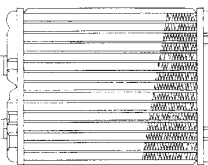

HTC-86388

VOLKSWAGEN

VEHICLE	MODEL / CODE	YEAR	PART No.	TYPE / OTHER / OEM REFERENCE
GOLF, PASSAT		1990 - ON	HTC-89932	
TRANSPORTER			HTC-89976	



HTC-89932

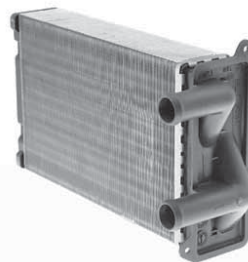

HTC-89976

VOLVO

VEHICLE	MODEL / CODE	YEAR	PART No.	TYPE / OTHER / OEM REFERENCE
240			HTC-90122	

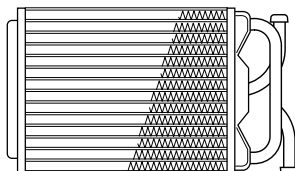

HTC-90122

Heaters: Replacement Parts**HEATER ACCESSORIES**

PART No.	ITEM	MODEL - APPLICATION	OTHER
HO-15058	HEATER HOSE	16 mm (5/8" I.D.) 15 m ROLL	

(1/2" and 3/4" Heater Hose are available on request)

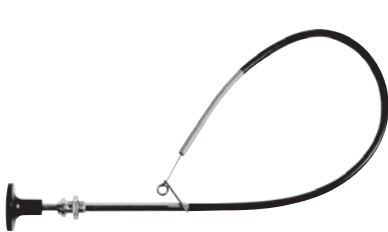
HEATER CABLES AND FITTINGS

HTC-94120

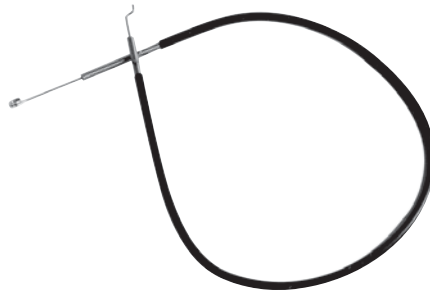

HTC-94124



HTC-94180



HTC-94200



HTF-94558



HTF-94658

PART No.	ITEM	MODEL - APPLICATION	OE PART No.
HTC-94120	CABLE	HEATER VALVE 20" (508 mm)	RD-4124-20
HTC-94124	CABLE	HEATER VALVE 24" (610 mm)	RD-4180-24
HTC-94180	CABLE	HEATER VALVE 76" (1900 mm)	RD-72R7700
HTC-94200	CABLE	HEATER VALVE 76" (1900 mm)	RD-72R8400
HTF-94558	FITTING	HOSE 5/8" STRAIGHT	RD-70R7600
HTF-94658	FITTING	HOSE 5/8" 90 DEG.	RD-70R7650

Technical Tip

System performance is often adversely affected by faults in the heating system.

Heater Valves / Controls / Airflow Shutters

- Faulty heater valves, cables, controls, and airflow shutters may mean that the heater is affecting the air temperature at the vents even when the heater controls are in the "off" position.
- If the system is operating normally, and the evaporator coil temperature is normal, but the vent temperature is not normal, check the heater system for faults.

For more information on evaporators / heaters and diagnosis, refer to pages 424 - 425 and the diagnosis charts on pages 447 - 448 in the Technical Section.

Heaters: Replacement Parts

HEATER VALVES



**HTV-32402
HTV-38197**



HTV-32446



HTV-32465

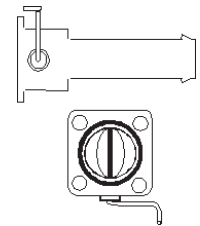

HTV-37537

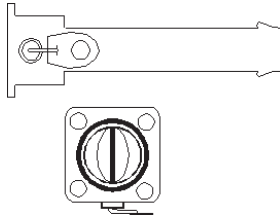

HTV-38070



HTV-38185

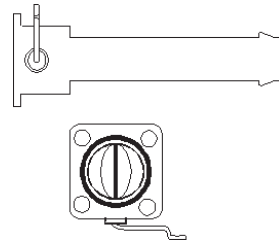

HTV-65362

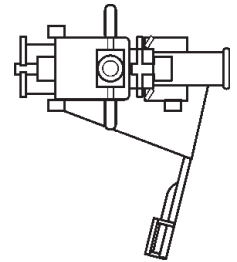

HTV-67226

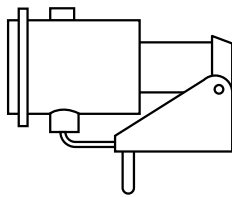

HTV-70822

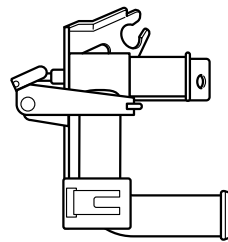

HTV-86333



HTV-97550 (5/8")



HTV-98762



HTV-98775 (5/8")



HTV-98781



HTV-98786

PART No.	ITEM	MAKE - MODEL - APPLICATION	OE PART No.
HTV-32402	WATER VALVE	FORD FALCON XD-XE-XF 6-CYL	YG-136
HTV-32446	WATER VALVE	FORD FALCON EA - AU 6-CYL	EA18495A
HTV-32465	WATER VALVE	FORD FALCON EA - AU 8-CYL	EC18495C
HTV-37537	WATER VALVE	G.M. ASTRA LD	
HTV-38185	WATER VALVE	G.M. BARINA SB	
HTV-38070	WATER VALVE	G.M. COMMODORE VK - VL 6-CYL	
HTV-38185	WATER VALVE	G.M. COMMODORE VN - VS 6-CYL	92036186
HTV-38185	WATER VALVE	G.M. COMMODORE VT - VY V-8 (5.7 litre)	92036186
HTV-38197	WATER VALVE	G.M. COMMODORE VN - VS V-8	92034915
HTV-38197	WATER VALVE	G.M. COMMODORE VT V-6	92034915
HTV-65362	WATER VALVE	MITSUBISHI COLT RB - RE	
HTV-67226	WATER VALVE	MITSUBISHI SIGMA GE - GH	
HTV-70822	WATER VALVE	NISSAN BLUEBIRD SERIES III	
HTV-37537	WATER VALVE	NISSAN PULSAR N13	
HTV-86333	WATER VALVE	TOYOTA COROLLA AE82	
HTV-97550	WATER VALVE	RED DOT (NORMALLY OPEN, PULL TO CLOSE)	RD-72R5060
HTV-98762	WATER VALVE	RED DOT (NORMALLY CLOSED, PULL TO OPEN)	RD-72R5230
HTV-98775	WATER VALVE	RED DOT (NORMALLY CLOSED, PULL TO OPEN)	RD-72R5040
HTV-98781	WATER VALVE	RED DOT (NORMALLY CLOSED, PULL TO OPEN)	RD-72R5220
HTV-98786	WATER VALVE	RED DOT (NORMALLY OPEN, PULL TO CLOSE)	RD-72R5270 (5-5495-2)