

SWITCHES

QUICK - REFERENCE GUIDE

ITEM	DETAILS	PAGE
SWITCHES, A - C / FAN CONTROL		
-	VEHICLE APPLICATION LISTING	352
-	ILLUSTRATED LISTING	353 - 354
	A M C	353
	KYSOR	353
	RED DOT	354
	UNDERDASH	354
SWITCHES, SYSTEM PROTECTION (safety cut-out switches)		
-	PRESSURE SWITCHES, UNIVERSAL	355 - 356
-	PRESSURE SWITCHES, OEM REPLACEMENT	357
-	SUPERHEAT SWITCHES	356
-	TEMPERATURE SWITCHES	356

Switches: A - C**OEM REPLACEMENT A-C SWITCHES**

PART No.	VEHICLE MAKE	EVAPORATOR MAKE	EVAP/VEHICLE TYPE/MODEL	MODEL CODE	REPLACES OE PART No.	OTHER INFORMATION
SWE-11202	N - A	AIR-CHIEF	EV-11202, EV-11262			
SWE-11282	N - A	AIR-CHIEF	EV-11242, EV-11282			
SWE-11472	N - A	SANDEN	611-747-850		51533-10030	
SWE-11474	N - A	SANDEN	848		CET2410C	
SWE-11592	N - A	UNICLA	SUPERKING	12V	CN0111	
SWE-11594	N - A	UNICLA	SUPERKING	24V	CN0111-24V	
SWE-12202	N - A	AMC	CM500, CM1000, CM2000		09-2928	
SWE-12342	N - A	KYSOR	KA200, KA700	12V	220300	
SWE-12344	N - A	KYSOR	KA200, KA700	24V	220268	
SWE-12425	N - A	RED DOT	R2000 (LATE)		5-3646-0; 71R1150	
SWE-12832	N - A	RED DOT	R7810		4151-2 71R0550	
SWE-12842	N - A	RED DOT	R7830		4123-2 71R0200	
SWE-12872Z	N - A	RED DOT	R8545		5-4694-1; 71R0450	
SWE-31486	FORD	COOLTEMP	B2000		SW-1002	
SWE-31606	FORD	COOLTEMP	COURIER	PD	SW-1068	
SWE-33456	FORD	COOLTEMP	LASER	KB	SW-1011	
SWE-33486	FORD	COOLTEMP	LASER	KC	SW-1003	
SWE-33526	FORD	COOLTEMP	LASER	KF	SW-1036	
SWE-33576	FORD	COOLTEMP	LASER	KJ	SW-1063	
SWE-34026	FORD	COOLTEMP	MAVERICK		SW-1027	
SWE-34156	FORD	COOLTEMP	TELSTAR	AS	SW-1005	
SWE-34176	FORD	COOLTEMP	TELSTAR	AT	SW-1007	
SWE-34386	FORD	COOLTEMP	TRADER 1990 on		SW-1038	
SWE-37546	G.M.	COOLTEMP	ASTRA	LD	SW-1001	
SWE-37626	G.M.	COOLTEMP	BARINA	ML	SW-1006	
SWE-37646	G.M.	COOLTEMP	BARINA	MF	SW-1037	
SWE-37720	G.M.	AIR-CHIEF	CAMIRA	JB - JD	VS15682	
SWE-37736	G.M.	COOLTEMP	CAMIRA	JE	SW-1010	
SWE-38188	G.M.	AIR INT.	COMMODORE	VN	09-20557	
SWE-38193	G.M.	OEM	COMMODORE	VR, VS		
SWE-40396	G.M.	COOLTEMP	JACKAROO, RODEO		SW-1004	
SWE-40426	G.M.	COOLTEMP	RODEO		SW-1042	
SWE-45306	HYUNDAI	COOLTEMP	EXCEL		SW-1014	
SWE-45316	HYUNDAI	COOLTEMP	EXCEL		SW-1050	
SWE-45336A	HYUNDAI	COOLTEMP	EXCEL	KMHU	SW-1059	
SWE-45336B	HYUNDAI	COOLTEMP	EXCEL		SW-1061	
SWE-60506	MAZDA	COOLTEMP	ASTINA		SW-1041	
SWE-65366	MITSUBISHI	COOLTEMP	COLT	RD	SW-1015	
SWE-65736	MITSUBISHI	COOLTEMP		FK-FM	SW-1019	
SWE-65826	MITSUBISHI	COOLTEMP	LANCER CA, PAJERO		SW-1033	WITH ROTARY SWITCH
SWE-65846	MITSUBISHI	COOLTEMP	LANCER	CC	SW-1053	
SWE-66236	MITSUBISHI	COOLTEMP	LANCER	CE	SW-1069	
SWE-65966	MITSUBISHI	COOLTEMP	L300	SF	SW-1016	
SWE-66166	MITSUBISHI	COOLTEMP	MAGNA		SW-1008	
SWE-66236	MITSUBISHI	COOLTEMP	MAGNA	TE	SW-1069	OE: MR201434
SWE-66356	MITSUBISHI	COOLTEMP	NIMBUS		SW-1017	
SWE-66626	MITSUBISHI	COOLTEMP	PAJERO		SW-1018	
SWE-67286	MITSUBISHI	COOLTEMP	SIGMA	GJ-GN	USE SWE-66626**	
SWE-70169	NISSAN	AIR-CHIEF	NISSAN	200B	USE SW - 41505**	OE-0112101 (ALSO AWA)
SWE-71936	NISSAN	COOLTEMP	NAVARA		SW-1020	
SWE-72426	NISSAN	COOLTEMP	PINTARA		SW-1021	
SWE-72556	NISSAN	COOLTEMP	PULSAR	N14	SW-1047	
SWE-72566	NISSAN	COOLTEMP	PULSAR	N15	SW-0103	
SWE-85186	TOYOTA	COOLTEMP	CAMRY	SV21	SW-1022	
SWE-85206	TOYOTA	COOLTEMP	CAMRY	DV10	SW-1055	
SWE-86106	TOYOTA	COOLTEMP	CORONA	ST141	SW-1024	
SWE-86326	TOYOTA	COOLTEMP	COROLLA	AE82	SW-1023	STANDARD
SWE-86326A	TOYOTA	COOLTEMP	COROLLA	AE82	SW-1049	CET TYPE
SWE-86954	TOYOTA	AMC	HI-ACE		09-2921	
SWE-86966	TOYOTA	COOLTEMP	HI-ACE		SW-1066	
SWE-87356	TOYOTA	COOLTEMP	HILUX	TO 1989	SW-1025	
SWE-87376	TOYOTA	COOLTEMP	HILUX	1989 -	SW-1035	
SWE-88104	TOYOTA	AMC	L/CRUISER	HJ47	09-0965	
SWE-88366	TOYOTA	COOLTEMP	L/CRUISER	HJ60	SW-1026	
SWE-88386	TOYOTA	COOLTEMP	L/CRUISER	HJ80	SW-1039	
SWE-88446	TOYOTA	COOLTEMP	L/CRUISER	HJ70	SW-1009	HZJ70 - 75
SWE-98512	ROOFTOP	KYSOR	KA300, E20000	12V	220743	
SWE-98524	ROOFTOP	KYSOR	KA300, E20000	24V	220746	

Switches: A - C

UNIVERSAL A-C SWITCHES

Push - Button A - C Switches

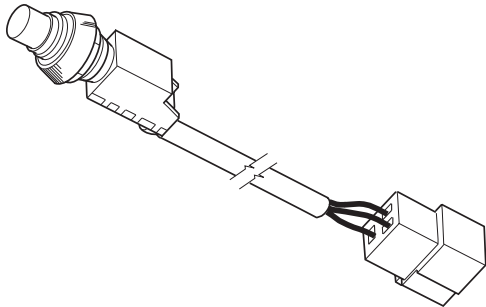

SW-41505
12 volt PUSH BUTTON A-C SWITCH
(ILLUMINATED BUTTON WHEN ON)

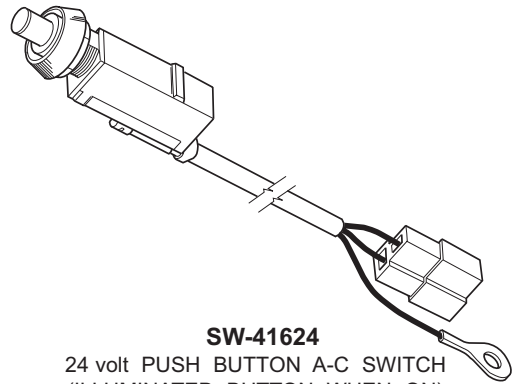

SW-41624
24 volt PUSH BUTTON A-C SWITCH
(ILLUMINATED BUTTON WHEN ON)

Rotary A - C Switches

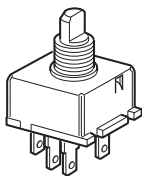

SW-42010
A-C SWITCH
5-PRONG, 3-SPEED
FOR USE WITH 12 OR 24 volt.
(USED WITH RESISTOR
OR 3-SPEED MOTOR)

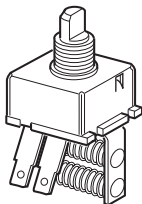

SW-42050 - 12 volt
SW-42054 - 24 volt
A-C SWITCH
RESISTOR TYPE, 3-SPEED
(FOR USE WITH SINGLE
SPEED MOTOR)

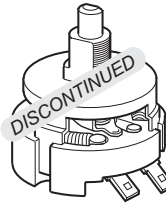

SW-42075
(DISCONTINUED - NLA)
RHEOSTAT VARIABLE SPEED
A-C SWITCH.
(FOR USE WITH SINGLE
SPEED MOTOR)

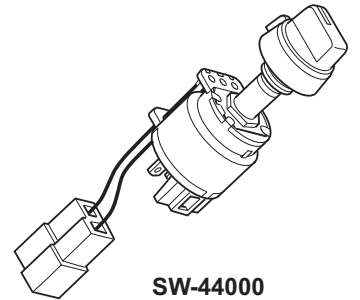

SW-44000
COMBINATION A-C SWITCH
AND THERMOSTAT CONTROL.
(FOR USE WITH THM-10100
THERMISTOR AND THO-10112
THERMO-AMPLIFIER)

SWITCH RETAINING NUTS

SWN-92850 - IMPERIAL
SWN-92900 - METRIC



OEM REPLACEMENT A-C SWITCHES

AMC

SWE-12202
AMC MODELS CM500, CM1000, CM2000



Kysor

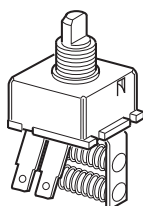

RESISTOR TYPE, 3-SPEED A-C SWITCH
KYSOR E20000, KA200, KA700
SWE-12342 - 12 volt (REPLACES KYSOR 220300)
SWE-12344 - 24 volt (REPLACES KYSOR 220268)

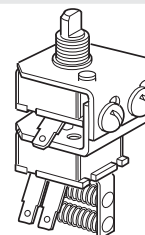

TANDEM RESISTOR, 3-SPEED A-C SWITCH
(KYSOR KA-300)
SWE-98512 - 12 volt (REPLACES KYSOR 220743)
SWE-98524 - 24 volt (REPLACES KYSOR 220746)

Switches: A - C**OEM REPLACEMENT A-C SWITCHES****Red Dot**

SWE-12425
A-C SWITCH
RED DOT R2000 (LATE)
RED DOT 5-3646-0; 71R1150

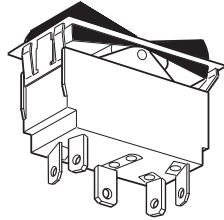

SWE-12832
A-C SWITCH, ROCKER TYPE
RED DOT R7810
RED DOT 4151-2; 71R0550



SWE-12842
A-C SWITCH, TOGGLE TYPE
RED DOT R7830
RED DOT 4123-2; 71R0200

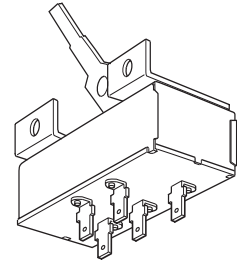

SWE-12872Z
A-C SWITCH, LEVER TYPE
RED DOT R8545
RED DOT 5-4694-1; 71R0450

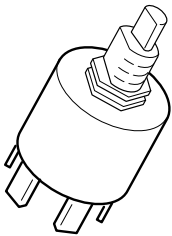
Switches: A - C**A-C SWITCHES: UNDERDASH UNITS**

SWE-11202



SWE-11282



SWE-11472



SWE-11474



SWE-11592
SWE-11594

PART No.	MAKE	EVAPORATOR	SWITCH TYPE		OE PART No.
SWE-11202	AIR-CHIEF	EV-11202; EV-11262	12v	3-SPEED ROTARY (FAN SWITCH ONLY)	SWE-11202
SWE-11282	AIR-CHIEF	EV-11242; EV-11282	12v	3-SPEED COMBINATION SWITCH/THERMOSTAT	SWE-11282
SWE-11472	SANDEN	611, 747 & 850	12v	COMBINATION SWITCH/THERMOSTAT (ELECTRONIC)	51533-10030
SWE-11474	SANDEN	848	24v	COMBINATION SWITCH/THERMOSTAT (ELECTRONIC)	CET2410C
SWE-11592	UNICLA	SUPERKING	12v	COMBINATION SWITCH/THERMOSTAT (ELECTRONIC)	CN0111
SWE-11594	UNICLA	SUPERKING	24v	COMBINATION SWITCH/THERMOSTAT (ELECTRONIC)	CN0111-24

Pressure Switches

Special Note

UNDER THE FEDERAL CODE OF PRACTICE, ALL AUTOMOTIVE AIR CONDITIONING SYSTEMS MUST HAVE HIGH AND LOW PRESSURE CUT-OUT SWITCHES.

NEVER INCREASE THE SPECIFICATION OF THE SWITCH SIMPLY TO OVERCOME A PROBLEM; FIX THE PROBLEM.

(Conversion Factors: 1 psi = 0.07031 kg/cm² = 6.895 kPa)

FAN CUT - IN SWITCHES

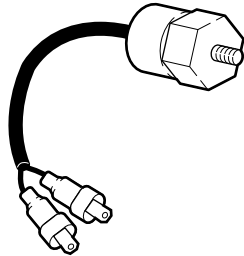

SW-49418
FAN CUT-IN SWITCH, MALE
SUITS MERCEDES W116, W123

HIGH / LOW PRESSURE CUT-OUT SWITCHES

(BINARY SWITCHES)

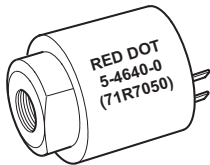

SW-49500

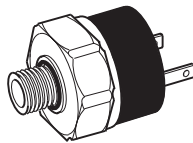

SW-49528
SW-49547
SW-49548
SW-49568

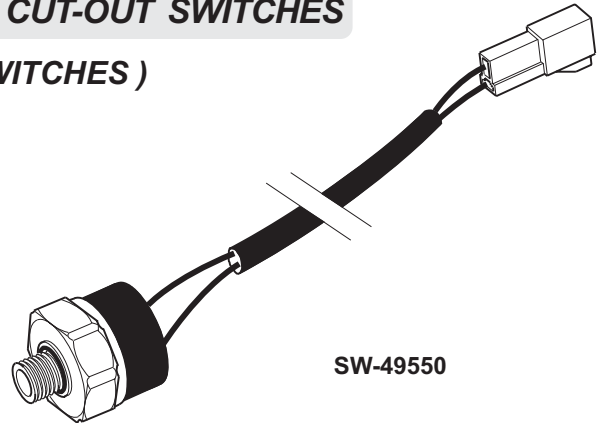

SW-49550

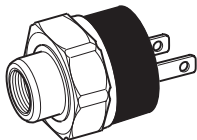

SW-49513
SW-49518
SW-49520

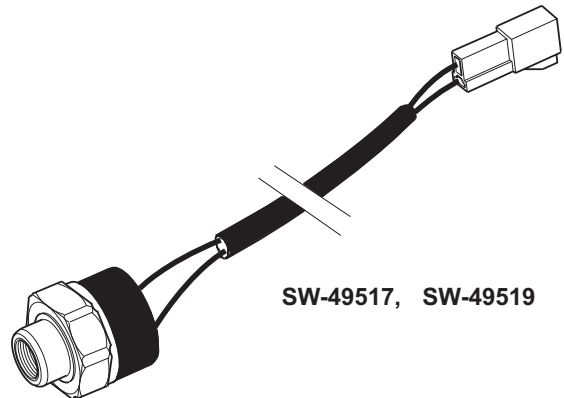

SW-49517, SW-49519

PART No.	MAKE	TYPE	HIGH SIDE CUT - OUT	HIGH SIDE CUT - IN	LOW SIDE CUT - OUT	OTHER INFORMATION
SW-49500	RED DOT	FEMALE	300 + 30 psi	170 - 230 psi	22.5 + 7.5 psi	2 SPADE TERMINALS
SW-49513	AIR CHIEF	FEMALE	320 + 28.4 psi	190 - 290 psi	28.4 + 2.8 psi	2 SPADE TERMINALS
SW-49517	AIR CHIEF	FEMALE	384 + 28.4 psi	270 - 324 psi	28.4 + 2.8 psi	2 - PIN PLUG
SW-49518	AIR CHIEF	FEMALE	384 + 28.4 psi	190 - 290 psi	28.4 + 2.8 psi	2 SPADE TERMINALS
SW-49519	AIR CHIEF	FEMALE	448 + 42.7 psi	330 - 410 psi	28.4 + 2.8 psi	2 - PIN PLUG
SW-49520	AIR CHIEF	FEMALE	384 + 28.4 psi	190 - 290 psi	28.4 + 2.8 psi	2 SPADE TERMINALS
SW-49528	AIR CHIEF	MALE	335 + 28.4 psi	190 - 290 psi	28.4 + 2.8 psi	2 SPADE TERMINALS
SW-49547	AIR CHIEF	MALE	384 + 28.4 psi	270 - 324 psi	28.4 + 2.8 psi	2 SPADE TERMINALS
SW-49548	AIR CHIEF	MALE	384 + 28.4 psi	270 - 324 psi	28.4 + 2.8 psi	2 SPADE TERMINALS
SW-49550	AIR CHIEF	MALE	384 + 28.4 psi	270 - 324 psi	28.4 + 2.8 psi	2 - PIN PLUG
SW-49568	AIR CHIEF	MALE	455 + 42.7 psi	330 - 410 psi	28.4 + 2.8 psi	2 SPADE TERMINALS

Pressure / Temperature Switches

HIGH/LOW CUT-OUT/FAN CUT-IN SWITCHES

(TRINARY SWITCHES)

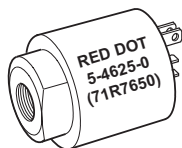

SW-49588
RED DOT
5-4625-0 (71R7650)

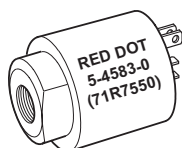

SW-49590
RED DOT
5-4583-0 (71R7550)

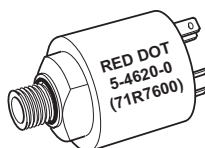

SW-49593
RED DOT
5-4620-0 (71R7600)

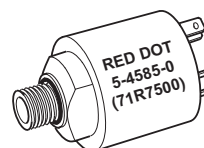

SW-49596
RED DOT
5-4585-0 (71R7500)

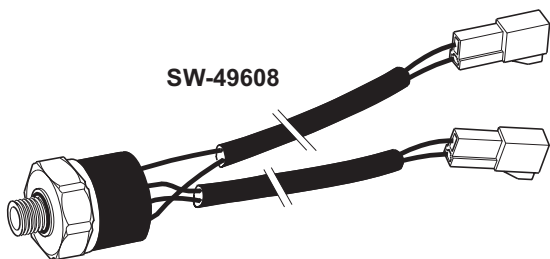

SW-49608

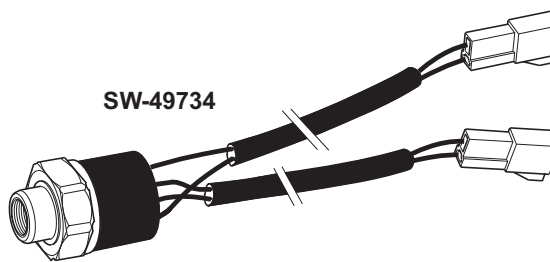

SW-49734

PART No.	MAKE	TYPE	HIGH SIDE CUT - OUT	HIGH SIDE CUT - IN	LOW SIDE CUT - OUT	FAN CUT-IN	FAN CUT-OUT	FAN CUT-IN OPEN/CLOSED
SW-49588	RED DOT	FEMALE	325 + 25 psi	210 - 250 psi	22.5+ 7.5 psi	215 + 15 psi	165 + 15 psi	NORM. CLOSED
SW-49590	RED DOT	FEMALE	325 + 25 psi	210 - 250 psi	22.5+ 7.5 psi	215 + 15 psi	165 + 15 psi	NORM. OPEN
SW-49593	RED DOT	MALE	325 + 25 psi	210 - 250 psi	22.5+ 7.5 psi	215 + 15 psi	165 + 15 psi	NORM. CLOSED
SW-49596	RED DOT	MALE	325 + 25 psi	210 - 250 psi	22.5+ 7.5 psi	215 + 15 psi	165 + 15 psi	NORM. OPEN
SW-49608	AIR CHIEF	MALE	390 + 28.4 psi	280 - 324 psi	28.4+ 2.8 psi	240 + 15 psi	160 + 15.0 psi	NORM. OPEN
SW-49734	AIR CHIEF	FEMALE	390 + 28.4 psi	280 - 324 psi	28.4+ 2.8 psi	240 + 15 psi	160 + 15.0 psi	NORM. OPEN

NOTE: PRESSURE CUT-OUT SWITCHES ARE NORMALLY CLOSED, AND 'OPEN' OR 'CUT-OUT' WHEN THE SPECIFIED PRESSURE IS REACHED. FAN/SHUTTER SWITCHES CAN BE NORMALLY OPEN OR NORMALLY CLOSED.

HIGH TEMPERATURE CUT - OUT SWITCHES

SW-85300
SW-85315

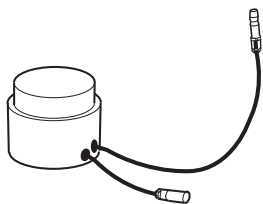

SW-85328

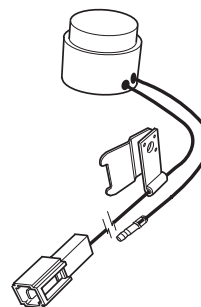

PART No.	CUT - OUT	TERMINALS	OEM APPLICATION
SW-85300	CUT-OUT: 135 deg. C.	M & F BULLETS	SANDEN TR70 OE: 9758-0901
SW-85315	CUT-OUT: 115 deg. C.	M & F BULLETS	SANDEN TR105 OE: 9767-0901 COMMODORE VN - VR V6
SW-85328	CUT-OUT: 115 deg. C.	SPADE - BULLET	SANDEN TR105 OE: 2200-6410 FALCON EA - ED 6cyl

HIGH TEMPERATURE CUT-OUT SWITCHES CLAMP TO THE LIQUID LINE OR ARE SEATED IN THE COMPRESSOR BODY AND SENSE HIGH SIDE TEMPERATURE.

THEY PERFORM THE SAME FUNCTION AS HIGH PRESSURE CUT-OUT SWITCHES.

NORMALLY CLOSED, THERMAL CUT-OUT SWITCHES CUT OUT WHEN PRESSURE IN THE HIGH SIDE INDICATES THE SPECIFIED CUT-OUT TEMPERATURE.

DELCO (HARRISON) PROTECTION SWITCHES

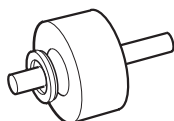

SW-83200
SUPERHEAT SWITCH.
FITS SUPERHEAT TYPE HEAD ON DELCO
A6 AND R4 COMPRESSORS.
USED WITH SW-83250.

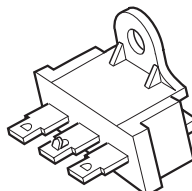

SW-83250
THERMAL LIMITER FUSE
USED ON SOME DELCO SYSTEMS
WITH SUPERHEAT SWITCHES.

Pressure Switches

FORD SWITCHES

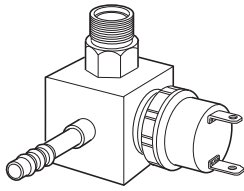

**FALCON XF
SIGHT-GLASS &
CUT-OUT SWITCH ASSY**
SW-90228 SIGHT GLASS
(w/out switch)
SW-90230 SIGHT GLASS
WITH HOSE

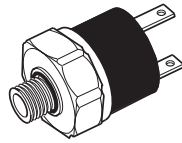

**FALCON
XF - EA - EL**
SW-49568
OE REPLACEMENT
SWITCH
(455 psi CUT-OUT)



**FALCON AU
TRANSDUCER**
SW-90250
BINARY SWITCH

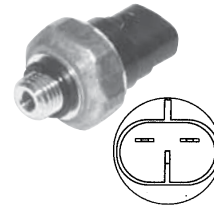

LASER KJ, KL
SW-90277
BINARY SWITCH

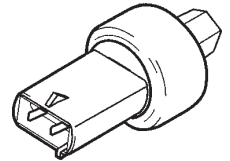

**FORD Universal
LOUISVILLE
MONDEO**
SW-90293 LP SWITCH

GM / HOLDEN SWITCHES

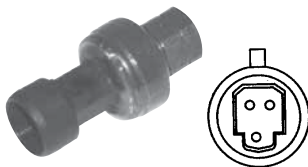

**GM: ASTRA TS
BARINA XC**
TRANSDUCER
SW-90395

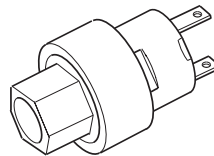

SW-90418
(s/sedes SW-85225)
GM CLUTCH CYCLING SWITCH
A VARIATION ON THE LOW PRESSURE CUT OUT SWITCH.
UNLIKE NORMAL LP SWITCHES, IT IS USUALLY INSTALLED
ON THE ACCUMULATOR ON THE LOW SIDE OF THE SYSTEM.
CUT-OUT: 27 psi CUT-IN: 35 psi
REPLACES OEM 3041409 AND 3041596

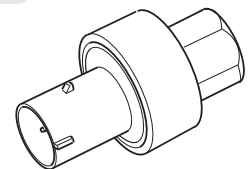

GM COMMODORE VN
LP SWITCH (CUT-OUT: 9 psi)
REPLACES OEM VS18874
SW-90420
(s/sedes SW-85240)

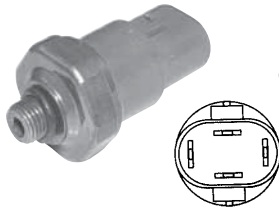

GM COMMODORE VR, VS
TRINARY SWITCH
CUT-OUT: 450 / 28 psi
FAN CUT-IN: 245 psi
SW-90425

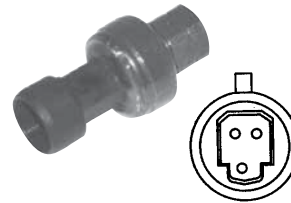

SW-90433
TRANSDUCER
COMMODORE VT, VX, VY
DELPHI COMPRESSOR

OTHER OEM PROTECTION SWITCHES

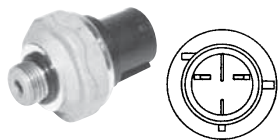

HONDA ACCORD 1990 on
BINARY SWITCH, 3/8" x 24 UNF
CUT-OUT: 455 / 28 psi
SW-90510



MITSUBISHI MAGNA TS
NIPPON DENSO "UNIVERSAL"
M11 x 1.0 THREAD
SW-90634

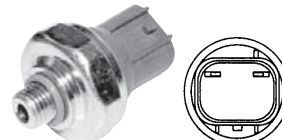

NIPPON DENSO
POPULAR SWITCH ON
NIPPON DENSO SYSTEMS
M11 x 1.0 THREAD
SW-90665

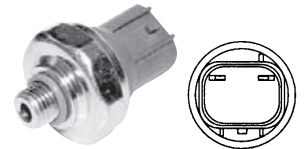

**MITSUBISHI
NIPPON DENSO**
BINARY SWITCH, 3/8" x 24 UNF
SW-90681

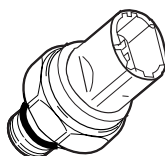

NISSAN PULSAR N15
BINARY SWITCH
SW-90700

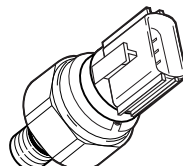

NISSAN PULSAR N16
TRANSDUCER
SW-90704



TOYOTA CAMRY 11/92 on
POPULAR SWITCH ON NIPPON DENSO SYSTEMS
TRINARY SWITCH : CUT-OUT: 455 / 28 psi
FAN CUT-IN: 17.5kg/cm²
SW-90852